



EXPLORER PLUS™ EXP EXPLORER™ EXR



Welcome to the future of laboratory weighing precision with the OHAUS Explorer Plus™ EXP Series and Explorer™ EXR Series. This new generation of laboratory balances designed to enhance your workflow with unparalleled user experience, outstanding weighing performance, advanced communication capabilities, and an eco-friendly design. Join us in discovering the possibilities with the OHAUS Explorer Series.



New OHAUS Explorer Series:
The Future of Laboratory Weighing

EXPLORER PLUS™ EXP

EXPLORER™ EXR



Table of Contents

Intelligent User Experience	4
Outstanding Weighing Performance	10
Supports Compliance for Data Traceability	12
Eco-Friendly Design	14
Weighing Applications	16
Model Comparison Table	18
Model Offering	19
Accessories	19



7-Inch Touchscreen Display

Vibrant colors, an easy-to-clean glass panel, and chemical resistance ensure a clear and durable interface.



Detachable Terminal and Base

Designed for flexibility, and suitable for small lab cabinets or fume hoods.



Effortless Setup and Monitoring

Motorized Leveling System with a digital-level bubble, that ensures a smooth and straightforward setup.



Intuitive Sample Handling and Reliable Status Indicators

- Features an intuitive sample spotlight that provides clear visibility, ensuring precise and hassle-free sample handling.
- Customized terminal and draftshield status lights provide clear and immediate feedback to underload or overload conditions.

Intelligent User Experience

Sample weighing kit includes Centrifuge Tube Holder, Rotary Evaporators Holder, Needle Holder, and Filter Paper Holder



Centrifuge Tube Holder



Rotary Evaporator Holder



 **How To: IR Sensor & Auto Door**
- Explorer™ Balance Series

Enhanced Anti-Pinch Automatic Draftshield Door

Safety protection with IR sensor operation for easy sample access and preventing hand injuries.

— Half-open design is tailored for powder samples that require a longer time to stabilize with airflow.



Half Open



Full Open



Open and Close with Anti-Pinch Sensor

Standard Square Weighing Pan

Designed for laboratory efficiency and specifically designed to assist in sample preparation. The semi-micro model pan is made with zinc alloy, the analytical and precision models have pans made with SST316 and the High-Capacity models with SST304.



Needle Holder



Filter Paper Holder



Semi-Micro Balance
(Zinc alloy)



Analytical Balance
(SST316)



Precision Balance
(SST316)



High-Capacity Balance
(SST304)

Sample Libraries Shared among Applications

- Apply to 15 weighing applications for Explorer Plus EXP and 11 for Explorer EXR. The large sample profile streamlines the workflow.
- 3000 sample libraries for Explorer Plus EXP and 1000 sample libraries for Explorer EXR.

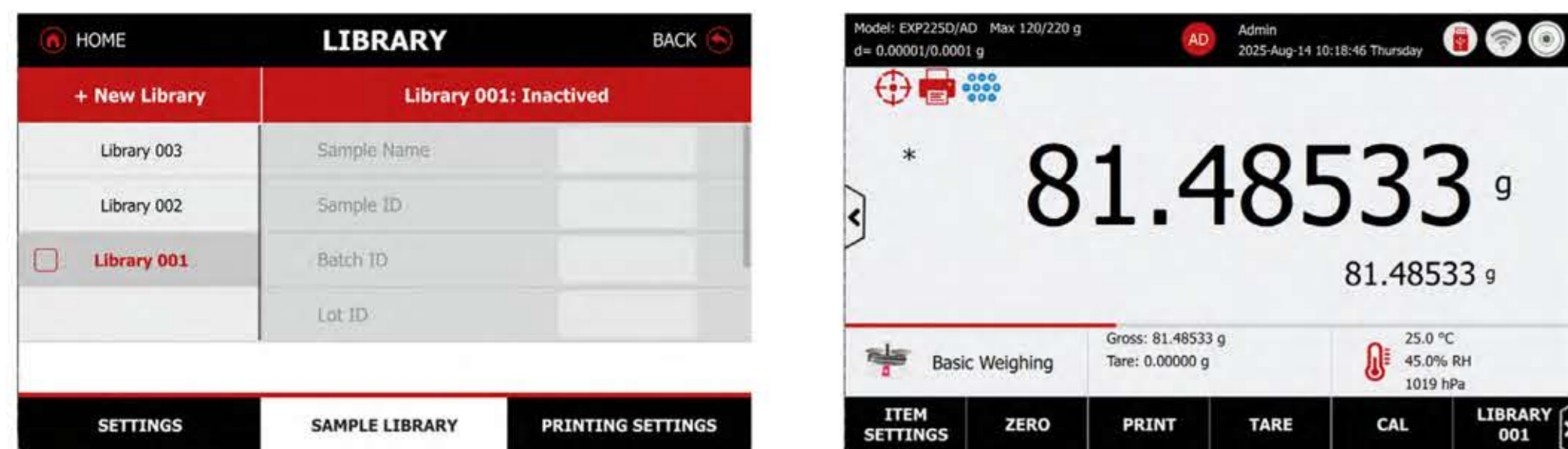

How To: Library Function - Explorer™ Balance Series

Out-of-Box Packaging

No assembly required, saving time and effort.

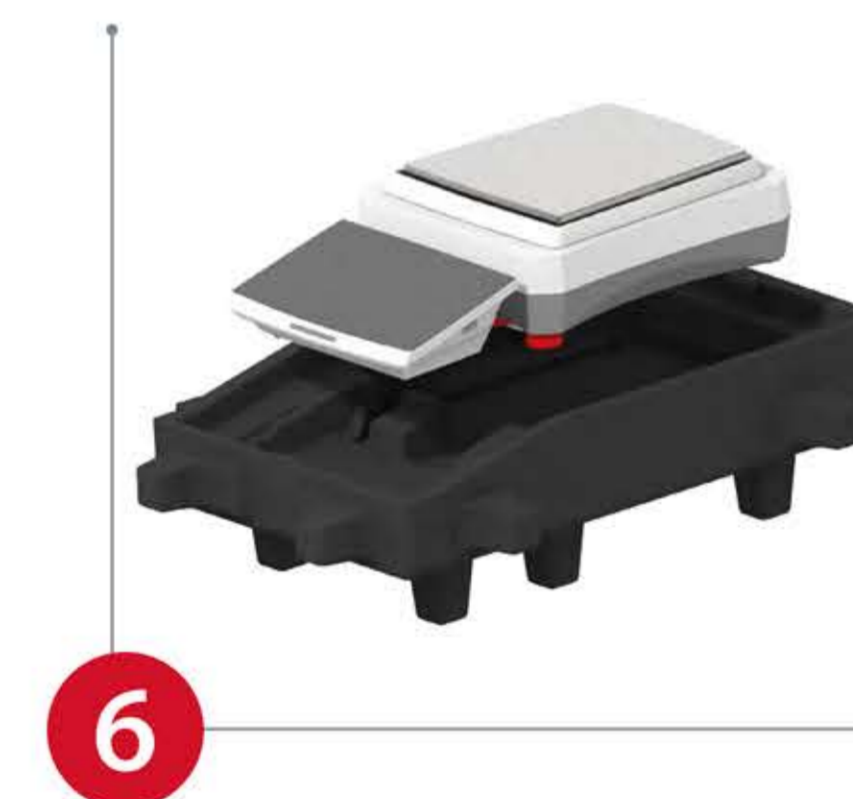
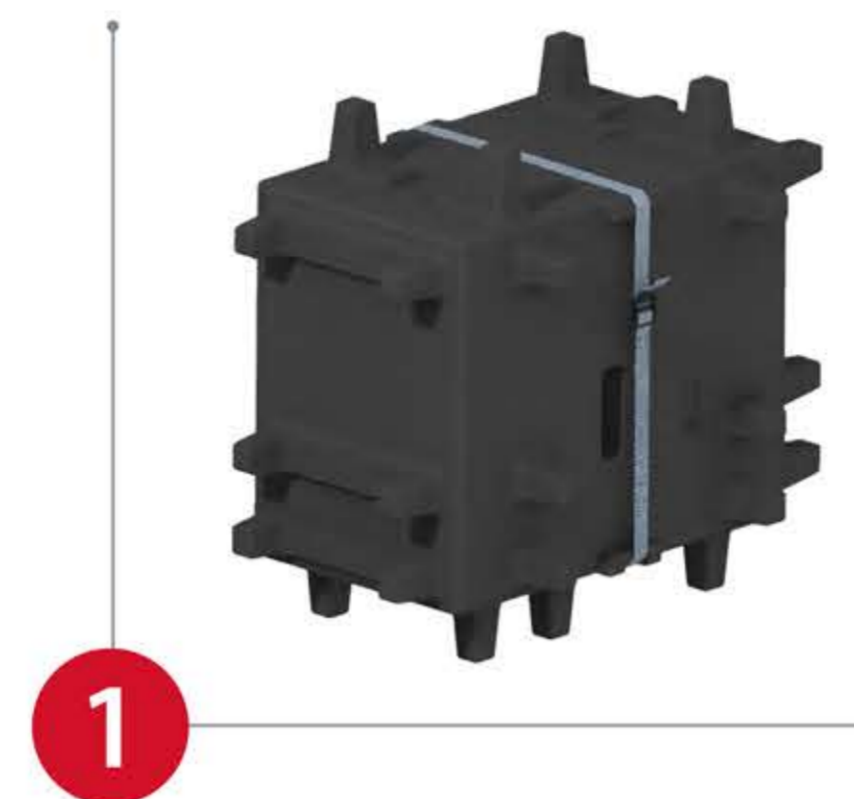

Removable Draftshield

For easy cleaning and long-term care and specific large volume weighing applications.



How To: Unpack and Installation - Explorer™ Balance Series



How To: Removing Draftshield - Explorer™ Balance Series

Outstanding Weighing Performance



Digital High-Speed Load Cell

The digital weighing components (DWC) offer the advantage of creating self-contained load cell modules. Rapid and precise measurements with this advanced technology ensures weighing processes are both swift and highly accurate.

Elevated Digital Load Cell Platform

Equipped with 3 ambient sensors to measure key load cell factors: temperature, humidity, and air pressure. Comprehensive monitoring ensures optimal weighing conditions, enhancing the accuracy and reliability of the measurements.

Internal Calibration Systems

Automatic, user-triggered, and span calibration options ensure precise measurements.



Anti-Static Draftshield

Reduces static electricity around the balance for consistent results.

Built-In Ionizer in Draftshield Models

Removes the static charge from the sample surface and neutralizes the weighing chamber for a stable environment.



Routine Repeatability Test

Ensures consistent long-term accuracy and reliability. Ideal for critical applications such as weighing in regulated environments, where meeting strict uncertainty requirements is essential (e.g., pharmacopeia mandates uncertainty $\leq 0.10\%$).

- The Minimum weight is calculated from the repeatability result.
- Regular monitoring of balance repeatability is essential, as it can vary over time or due to environmental changes.
- This application guides the user to perform the test, and then calculates the repeatability result and minimum weight value.

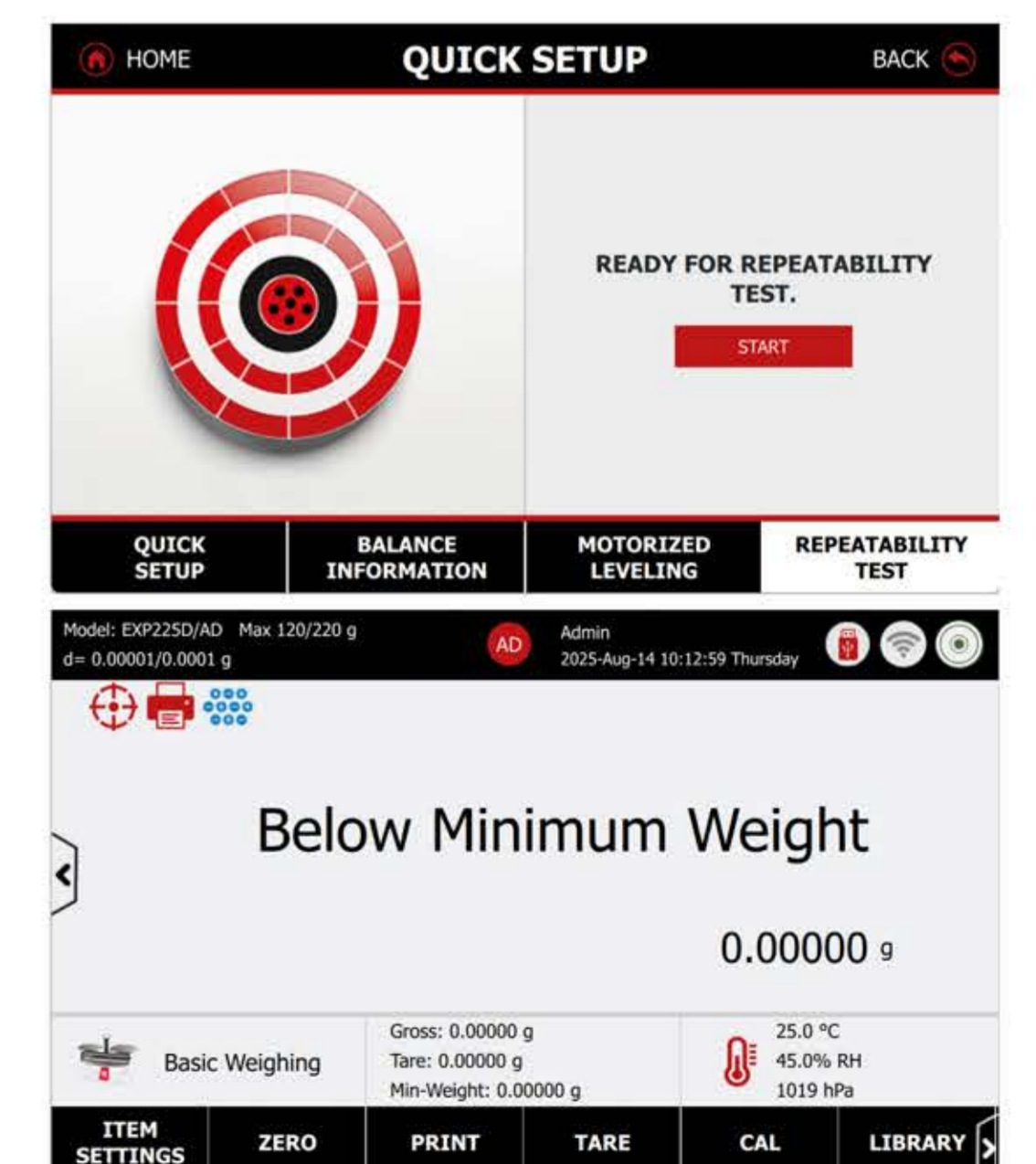

How To: Performance Test - Explorer™ Balance Series



Enhanced Security and User Management

Optional Fingerprint Login System for secure and personalized access. This accessory ensures that only authorized users can access the system, providing a high level of security and data protection.

User management system offering 4 levels of access with an internal system log capacity of 100,000 entries, enabling the tracking and monitoring of user activities efficiently, ensuring compliance and accountability.

 **How To: User Management**
- Explorer™ Balance Series

Supports Compliance for Data Traceability

Equipped with multiple USB ports, offering unparalleled flexibility. The direct to Excel feature is designed for users who lack the authorization to install drivers, providing a basic yet highly user-friendly solution for data transfer.



USB A and C ports, Bluetooth® and WiFi connectivity



RJ11 for Fingerprint accessory

USB A and USB C ports

Ethernet port

HID Connection

- Human Interface Device allows connections to computers without the need for drivers.
- Easy integration with LIMS and MES systems.



Time Synchronization

Network Time Protocol (NTP) ensures accurate timekeeping.



Electronic Signature

When the Electronic Signature feature is enabled, the User ID will be used in the printout field when the User ID content option is selected.

Direct Data Transfer

Direct export to Excel and saving data to USB in CSV and PDF formats.

Highly Flexible Connectivity

Explorer Plus™ EXP

- 2x USB Host Type A
- 1x USB Device Type B
- 1x USB Device Type C
- 1x Ethernet
- 1x RJ11 for Fingerprint accessory
- 1x RS-232
- 1x Optional Bluetooth® / WiFi dongle (through USB Host Type A)

Label Printing Function

2 preset templates and 10 customizable templates for semi-finished product samples transfer management.



System Log

All the changes made on balance setting will keep records in system log file. e.g. every printed data, date/time change, balance setting changes, perform calibration action, user log in/log out, user account create/edit/delete and etc. These system log files can be reviewed and exported as a PDF to a USB flash drive.



Explorer™ EXR

- 2x USB Host Type A
- 1x USB Device Type C
- 1x Ethernet
- 1x RS-232
- 1x Optional Bluetooth® / WiFi dongle (through USB Host Type A)



Incorporating recycled materials, implementing power-saving functions, utilizing dematerialized components, and reducing shipping weight supports sustainable product goals.

Power Consumption

65% reduction in Sleep Mode.



Reduced Shipping Weight

36% weight reduction for non-draftshield models, 64% weight reduction for draftshield models.



Recycled Materials

Up to 58% of total components. Aluminum Construction: Replaces most plastic materials for durability and sustainability.

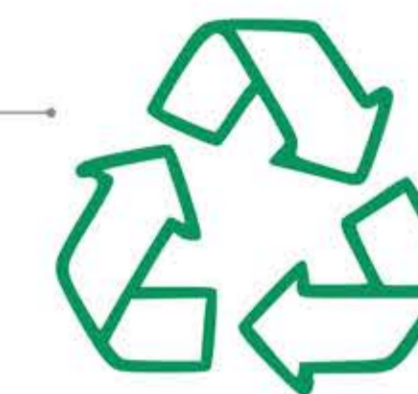

Dematerialization

Reduces the number of components to improve production efficiency.

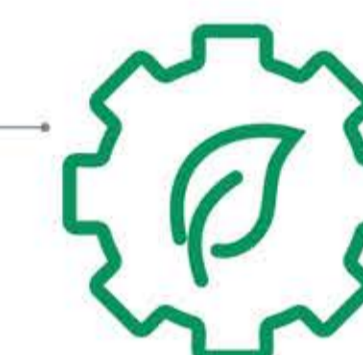

End-of-Life Instructions

A comprehensive disposal guide helps manage the end-of-life process efficiently. This guide includes practical tips for data management and recycling, ensuring the disposal process is both effective and environmentally responsible.



ACT Label Certification

Eleven models are certified with the ACT Label, highlighting their environmental impact.

The ACT certification is based on three labels: EU, UK, and US.

Example: EXP225D/AD

To learn more about the ACT labels, please visit www.ohaus.com/products.

ACT. EU	
The Environmental Impact Factor Label	
OHAUS Explorer Plus Analytical Balance and Precision Balance EXP225D/AD	
Changzhou, China	
SKU EXP225D/AD	
Environmental Impact Scale: Decreasing Environmental Impact (1 to 10)	
Manufacturing	
Manufacturing Impact Reduction	6.0
Renewable Energy Use	Yes
Responsible Chemical Management	1.0
Shipping Impact	10.0
Product Content	1.0
Packaging Content	1.0
User Impact	
Energy Consumption (kWh/day)	0.1
Water Consumption (liters/day)	N/A
Product Lifetime	5.0
End of Life	
Packaging	5.0
Product	5.0
Environmental Impact Factor:	34.3
Label Valid Through:	January 2027
act.mygreenlab.org	

ACT. US	
The Environmental Impact Factor Label	
OHAUS Explorer Plus Analytical Balance and Precision Balance EXP225D/AD	
Changzhou, China	
SKU EXP225D/AD	
Environmental Impact Scale: Decreasing Environmental Impact (1 to 10)	
Manufacturing	
Manufacturing Impact Reduction	6.0
Renewable Energy Use	Yes
Responsible Chemical Management	1.0
Shipping Impact	10.0
Product Content	1.0
Packaging Content	1.0
User Impact	
Energy Consumption (kWh/day)	0.1
Water Consumption (gallons/day)	N/A
Product Lifetime	5.0
End of Life	
Packaging	5.0
Product	4.8
Environmental Impact Factor:	33.9
Label Valid Through:	January 2027
act.mygreenlab.org	

Eco-Friendly Design



Weighing Applications

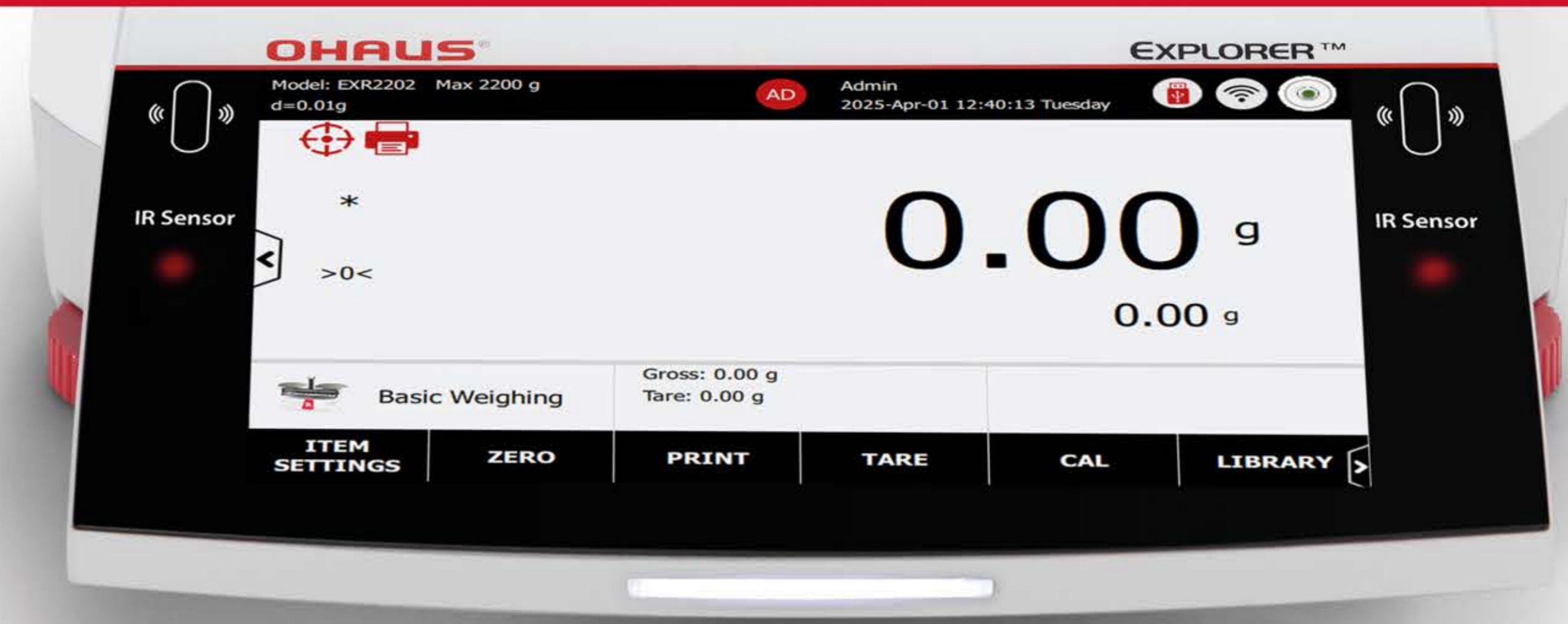

Basic Weighing

to determine the weight of items in the selected unit of measure.

Batch Printing (software feature of the Basic Weighing application) – to enable users to record and print a list of sample weights, with the capacity to handle up to 999 sample units in a single batch.



Parts Counting

to display the number of pieces or parts based on an average piece weight. Checks if the current sample pieces are within tolerances.



Check Counting

to check if the current sample pieces are within tolerances.



Percent Weighing

to display the current weight as a percentage of a reference weight.



Check Weighing

to check if the current weight is within tolerances.



Dynamic Weighing

to weigh objects that are not stable, such as animals.



Totalization

to sum the weights of multiple samples and report the statistical data for the series of samples.



Formulation

to combine various elements in proportionate amounts.



Differential

to calculate the difference in weights of multiple samples taken at different times.



Density Determination

to determine the density of a solid or a liquid



Peak Hold

to capture the maximum weight in a series of weighing.



Pipette Adjustment [EXP only]

to calculate the inaccuracy and imprecision of pipettes, used to check if a pipette's dosage is within tolerances.



SQC [EXP only]

to determine the homogeneity of items in batches over time.



Fill Weight Variation [EXP only]

to assess the uniformity of the weight of material dispensed into a container or mold throughout the manufacturing process.



Flow Rate Control [EXP only]

to manage the volume or mass of fluid (liquid or gas) that passes through a pump system over a specific period.

EXP vs. EXR

Model Comparison



Model	EXP	EXR
7-inch display with glass panel	●	●
Motorized leveling system	●	
Detachable terminal and base design	●	
Enhanced auto-doors with anti-pinch safety protection	●	
Sample spotlight - models with draftshield	●	
Fingerprint login (accessory)	●	
Built-in ionizer - models with draftshield	●	
3 ambient sensors (load cell temperature, humidity, air pressure)	●	
Time synchronization NTP (Network Time Protocol)	●	●
Label printing function (2 preset templates and 10 customized templates)	●	●
Draftshield status lights	●	
Terminal status lights	●	●
2 x IR sensors	●	●
Digital level bubble	●	●
Standard square weighing pan	●	●
Full metal housing	●	●
Removable draftshield	●	●
Out-of-box packaging design	●	●
Internal calibration systems	●	●
Draftshield with anti-static coating	●	●
Powder sample dosing mode	●	●
1~9 grade filter level	●	●
Digital load cell platform	●	●
HID (Human Interface Device) connection to a computer without drivers	●	●
4-level user management and an internal system log capacity of 100,000 entries	●	●
Sample libraries shared among applications	●	●
Basic Weighing, Parts Counting, Check Counting, Percent Weighing, Check Weighing, Dynamic Weighing, Totalization, Formulation, Differential, Density Determination, and Peak Hold	●	●
Process Weighing Applications: Pipette Adjustment, SQC, Fill Weight Variation, and Flow Rate Control	●	

Model Offering

Models	Semi-Micro	Analytical	Precision	High Capacity	
Explorer Plus EXP Models	EXP125D/AD EXP125/AD EXP225D/AD* EXP225/AD	EXP124/AD EXP224/AD* EXP324/AD*	EXP223/AD EXP423/AD EXP623/AD* EXP1203/AD* EXP2202 EXP4202	EXP6202 EXP8202 EXP12202 EXP6201 EXP8201 EXP10201	EXP24001 EXP35001 EXP65001
Explorer EXR Models	EXR125D* EXR125 EXR225D* EXR225	EXR124 EXR224* EXR324*	EXR223 EXR423 EXR623* EXR1203* EXR2202 EXR4202	EXR6202 EXR8202 EXR12202 EXR6201 EXR8201 EXR10201	

Notes:

This table highlights the similarities and differences between the EXP and EXR model offerings, as detailed in the provided information.

Both EXP and EXR model have secured OIML and NTEP certifications.

*Green models have the ACT certified labels

To learn more about the product specifications, please visit www.ohaus.com/products.

Accessories

 Bluetooth Printer, Impact, SF40A/BT 	 Printer, Impact, SF40A	 Fingerprint scanner FIN-100A 
 Bluetooth dongle and Wi-Fi dongle LM842 	 Static Ionizer, ION-100A	 Weighing Kit 
 Density Kit, Solids	 Sinkers, Glass, Liquid, Density Kit	 Pipette Evaporation Trap
 Tower Kit for EXP High-Capacity Model 	 Terminal Extension Cable, RS422, 9 m	
 SF40A Paper roll (57,5 mm 2 pcs)	 SF40A Ink Ribbon Cassette	



OHAUS Corporation

Headquartered in Parsippany, NJ, OHAUS Corporation manufactures an extensive line of balances and scales, lab equipment and lab instruments that meet the weighing, sample processing and measurement needs of multiple industries. We are a global leader in the laboratory, industrial and education markets, as well as a host of specialty markets, including the food preparation, pharmacy and jewelry industries. An ISO 9001:2015 manufacturer, OHAUS lab balances, industrial scales, lab equipment and lab instruments are precise, reliable and affordable, and backed by industry-leading customer support.

80777312_A 20260326 © Copyright OHAUS Corporation

OHAUS Asia/Pacific
Headquarters
e-mail: APmarketing@ohaus.com
Tel: +86 21 64855408

With offices throughout
Europe, Asia, and
Latin America

ISO 9001:2015

Registered Quality
Management System

